

OPERATOR'S MANUAL

and Set-Up Instructions for Grain Cart Hydraulic Drive Kit

HD-1SHS High Speed Hydraulic Drive (with 12 cubic inch motor)

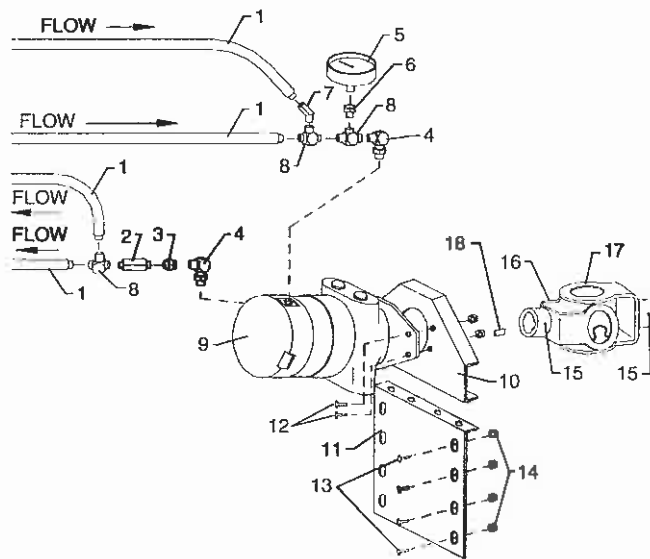

J. & M. Mfg. Co., Inc.

P.O. Box 547 Ft. Recovery, OH 45846
Ph: (419) 375-2376 Fax: (419) 375-2708

www.jm-inc.com

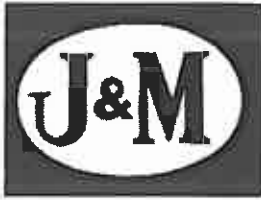

J. & M. MFG. Co., Inc.

284 Railroad Street P.O. Box 547
FORT RECOVERY, OHIO 45846

Phone (419) 375-2376

Set up Instructions and Operation of Model HD-1SHS Hydraulic Drive on J & M Grain Cart

IMPORTANT – Before installation and operation of the hydraulic drive, make sure to read this and all owner’s manuals on the machine.

Model HD-1SHS consists of the following:

<u>Ref. #</u>	<u>Part No.</u>	<u>Qty</u>	<u>Description</u>
1	HH-3466	4	¾" x 66" Hydraulic Hoses
2	CV-6P05	1	Check Valve
3	5404-12-12	1	¾" Nipple
4	AW6805-12-12-NWO	2	O-ring Adapter Fitting
5	3000	1	Pressure Gauge
6	5406-12-4	1	Reducer Bushing
7	5503-12-12	1	45 Degree Street Elbow
8	5602-12-12-12	3	Tee
9	DRF-12	1	Hydraulic Motor
10	UMMB-1	1	Upper Motor Mount Bracket
11	LMMB-1	1	Lower Motor Mount Bracket
12	12114MB	4	½" x 1 ¼" – 13 Hex Bolt –Grade 5
13	121MB	6	½" x 1" – 13 Hex Bolt
14	12LN	10	½" – 13 Lock Nut
15	3812SS	4	3/8" x ½" – 16 Set Screw
16	03-10134	1	Cross Kit (repair)
17	232-15846	1	U-Joint
18	KE-516	1	5/16" Key

IMPORTANT – MAKE SURE THAT ALL POWER IS SHUT OFF BEFORE INSTALLING HYDRAULIC DRIVE. Installation work to be performed by qualified servicemen only. Please refer to your operator’s manual for additional safety information.

Be sure to use SAE 10W40 or SAE 5W30 oil or tractor hydraulic fluid with high levels of zinc anti-wear additives (see your tractor owner’s manual). Type A, F or Dextron transmission fluid must Not be used. Hydraulic oil must never exceed 180 Degrees Fahrenheit. For optimum performance use 5 to 25 micron filtration on system.

Your hydraulic drive comes partially assembled. When mounting to the grain cart, attach the lower motor mount bracket (11) to the brackets welded on the frame of the grain cart using 4 – ½" x 1" Bolts (13) and 4 – ½" Lock Nuts (14) provided. Remove step guard from the frame of the grain cart. Attach the upper



J. & M. MFG. Co., Inc.

284 Railroad Street P.O. Box 547
FORT RECOVERY, OHIO 45846

Phone (419) 375-2376

motor mount bracket (10) to the lower motor mount bracket using 2 – ½" x 1" bolts and ½" lock nuts. Attach U-joint (17) to the cart driveshaft using 2 – 3/8" Set Screws (15). (Make sure that the key is secure on the driveshaft). Secure the step guard to the frame of the grain cart using the 3/8" nuts provided. Recheck all bolts, nuts, set screws and fittings and make sure that they are properly tightened. Insert the hoses into tractor hydraulic remote ports. CAUTION – Hydraulic oil leaking under pressure can penetrate the skin and cause infection or other injury.

To prevent personal injury:

Never use your hand to check for suspected leaks under pressure. Use a piece of cardboard or wood for this purpose. Before applying pressure, make sure all connections are tight and components are in good condition.

Relieve all pressure, before disconnecting fluid lines. If injured by leaking fluid, see your doctor immediately.

Before operating the hydraulic drive, make sure that your tractor hydraulic system delivers between 25 and 35 gallons per minute. CAUTION – The maximum pressure on the hydraulic motor is 2800 PSI and the maximum flow is 35 gallons per minute (intermittent use). AT NO TIME during the operation of this motor should the maximum pressure and the maximum flow occur simultaneously. (If the hydraulic drive is used continuous, the maximum GPM is 33).

Break In Period – Before placing the hydraulic motor into service, be certain to run the system at ½ speed under NO load for 15 minutes. CAUTION – Before operating the hydraulic drive, make sure that everyone is clear of the equipment before applying power. Operate the hydraulic drive from a safe distance. Always keep hands, feet, and clothing away from moving parts while the unit is in operation.

Operating Instructions – Before operating this machine, make certain that you have read and fully understood the operator's manual on the grain cart. If this machine is used by an employee or rented or loaned, make certain that the operator(s) have read all manuals, cautions, and warnings and understood as to the safe operation of the grain cart.

Before filling the grain cart, make certain that the gate indicator is in the closed position. Fill the grain cart with grain. After the cart is filled and ready for unload, position the auger to the upright position (follow the instructions in the grain cart owner's manual) and engage the hydraulic drive (start at idle speed and increase to operating speed). Slowly open the inner gate while checking the pressure gauge on the hydraulic motor. Once the pressure gauge reading is between



J. & M. MFG. Co., Inc.

284 Railroad Street P.O. Box 547
FORT RECOVERY, OHIO 45846

Phone (419) 375-2376

1800 and 1900 PSI, discontinue opening the gate (pressure is low under no load). NOTE – The size of the gate opening allowed and the unloading time will vary as to the type of grain, moisture content, quality of the grain and the GPM delivery of the tractor. Follow your owner's manual for details on complete cleanout. Once the grain has been unloaded from the tank of the grain cart, disengage the hydraulic drive and return the auger to the lowered position.

NOTE: If only one outlet is available, remove two 3/4" x 66" hydraulic hoses and plug the two tee fittings. (Performance of hydraulic drive will be reduced.)

MODEL HD-1SHP HYDRAULIC DRIVE KIT

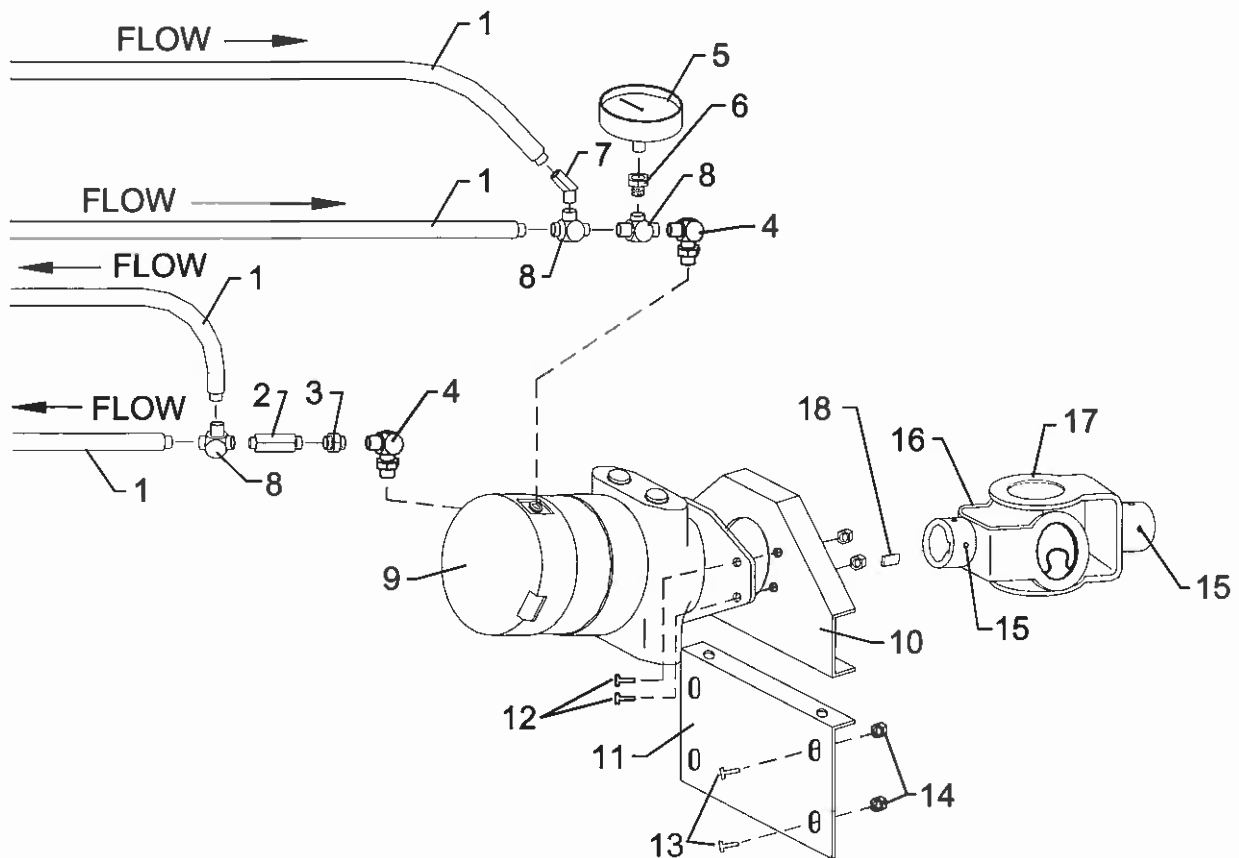

QUICK REFERENCE GUIDE

Model	Pressure Compensating Closed Center	Load Sensing Closed Center	Open Center
FMC-HYD-204	X		4-13 GPM
FMC-HYD-210		X	8-17 GPM
FMC-HYD-310			18-24 GPM
FMC-150-HYD-206	X	X	7-16 GPM
FMC-200-HYD-210	X	X	8-17 GPM
FMC-200-HYD-310			18-24 GPM
FMC-200-HYD-304	X	X	11-19 GPM

PC CLOSED CENTER

On Pressure Compensating Closed Center Systems, the flow of oil to the Ace hydraulic motor is controlled by using a calibrated **restrictor orifice**.

To set up: 1) Install the restrictor orifice in the intake port of the Ace motor. 2) Close the needle valve on the Ace motor by loosening the jam nut and screwing the needle valve in a clockwise direction all the way down.

LS CLOSED CENTER

On Load Sensing Closed Center Systems, also known as Pressure Flow Compensating (PFC) Systems, the flow of oil to the Ace hydraulic motor is controlled by adjusting the **flow control lever** on the tractor.

To set up: 1) Close the needle valve on the Ace motor by loosening the jam nut and screwing the needle valve in a clockwise direction all the way down. 2) Shut off boom and agitation valves on the sprayer. 3) Set the flow control lever on the tractor until the sprayer system dead head pressure is between 60 and 100 psi. 4) Open the agitation valve to get desired spraying pressure. (Note: Do not use the restrictor orifice.)

OPEN CENTER

On Open Center Systems, the flow of oil to the Ace hydraulic motor is controlled by adjusting the **needle valve** on the Ace hydraulic motor.

To set up: 1) Shut off boom and agitation valves on the sprayer. 2) Set tractor throttle to speed at which you will be spraying. 3) Loosen jam nut on hydraulic motor, and back out needle valve 3 or 4 turns. 4) Engage tractor hydraulic lever, then screw the needle valve clockwise until the sprayer system dead head pressure is between 60 and 100 psi, then lock the jam nut. 5) Open the agitation valve to get desired spraying pressure. (Note: Do not use the restrictor orifice.)

GENERAL NOTES

1. The tractor hydraulic system data contained in these tables should be used as a guide only. For more detailed information, consult your tractor manufacturer.

2. Tractors must have adequate oil cooling to operate a sprayer pump with a hydraulic motor. While most modern systems have excess oil cooling capacity, some systems may require an auxiliary cooler. As a rule of thumb, the maximum temperature for hydraulic oil is 100 degrees Fahrenheit over ambient.

3. On tractors with a hydraulic lever "Float" position, operate the sprayer pump in the "Lower" position and shut the pump off in the "Float" position. This eliminates high pressure from being trapped in the return line.

4. With the 210 and 310 motors the hydraulic system pressure may be insufficient to raise implements. Turn pump off to restore normal system pressure.

CAUTION: DO NOT EXCEED THE MAXIMUM SHUT-OFF PRESSURE. Failure to limit the flow of oil to hydraulic motor can result in motor seizure.
MAXIMUM SHUT-OFF PRESSURE RATINGS:
 100 PSI for FMC-HYD Series
 120 PSI for FMC-150-HYD Series

	Open or Closed Center System	Maximum Pressure Remote Outlets	Maximum Flow Remote Outlets US GPM	ACE PUMP MODEL RECOMMENDATION					
				1 X 1 SERIES			1 x 1 SERIES	2 x 1 SERIES	
				FMC-HYD-204	FMC-HYD-210	FMC-HYD-310	FMC-150-HYD-206	FMC-200-HYD-210 FMC-200-HYD-304	FMC-200-HYD-310
4650	OPEN (1)	2610	6.3	✓					
4660	OPEN (1)	2610	7.4	✓					
5650	OPEN (1)	2775	11	✓	✓		✓	✓	
5660	OPEN (1)	2775	11	✓			✓	✓	
5670	OPEN (1)	2610	8.9	✓			✓		
5680	OPEN (1)	2610	10.25/12.7	✓			✓	✓	
6670	OPEN (1)	2610	8.9	✓			✓	✓	
6680	OPEN (1)	2610	10.25/12.7	✓			✓	✓	
6690	OPEN (1)	2610	10.25/12.7	✓			✓	✓	
7600	OPEN (1)	2610	16.25		✓			✓	
7630	OPEN (1)	2610	16.25		✓			✓	
7650	OPEN (1)	2610	16.25		✓			✓	
8360	LS CLOSED	2500	27		✓		✓	✓	
8425	LS CLOSED	2500	27		✓		✓	✓	
8610	OPEN (1)	2610	14.75		✓		✓	✓	
8630	OPEN (1)	2610	14.75		✓		✓	✓	
8745	OPEN	3045	27.7		✓		✓	✓	
8765	OPEN	3045	27.7		✓		✓	✓	
8775	LS CLOSED	2900	27.7		✓		✓	✓	
8785	LS CLOSED	2900	27.7		✓		✓	✓	
9435	LS CLOSED	2900	27		✓		✓	✓	
9455	LS CLOSED	2900	27		✓		✓	✓	
9630	PC CLOSED	2250	24	✓			✓	✓	
9635	PC CLOSED	2250	22	✓			✓	✓	
9650	PC CLOSED	2250	24	✓			✓	✓	
9655	PC CLOSED	2250	22	✓			✓	✓	
9670	PC CLOSED	2500	23	✓			✓	✓	
9675	PC CLOSED	2500	22	✓			✓	✓	
9690	PC CLOSED	2500	23	✓			✓	✓	
9695	PC CLOSED	2500	22	✓			✓	✓	
9735	LS CLOSED	2900	27.7		✓		✓	✓	
9745	LS CLOSED	2900	27.7		✓		✓	✓	
9815	PC CLOSED	2750	22	✓			✓	✓	

(1) An auxiliary oil cooler may be required for continuous duty sprayer pump operations.

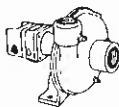
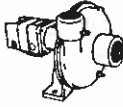
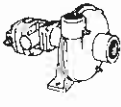
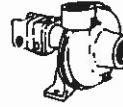
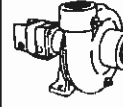
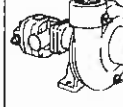

ACE PUMP MODEL RECOMMENDATION

	Open or Closed Center System	Maximum Pressure Remote Outlets	Maximum Flow Remote Outlets US GPM	ACE PUMP MODEL RECOMMENDATION					
									
				1 X 1 SERIES			1 x 1 SERIES	2 x 1 SERIES	
				FMC-HYD-204	FMC-HYD-210	FMC-HYD-310	FMC-150-HYD-206	FMC-200-HYD-210 FMC-200-HYD-304	FMC-200-HYD-310
160	OPEN	2300	6.7	✓					
170-G	OPEN	2000	10	✓	(1)		✓	✓	
170-D	OPEN	2000	10	✓	(1)		✓	✓	
175-G	OPEN	2400	11	✓	(1)		✓	✓	
175-D	OPEN	2400	11	✓	(1)		✓	✓	
180-G	OPEN	2000	10	✓	(1)		✓	✓	
180-D	OPEN	2000	10	✓	(1)		✓	✓	
185	OPEN	2000	10	✓	(1)		✓	✓	
185-D	OPEN	2400	11	✓	(1)		✓	✓	
190-D	OPEN	2000	12.75	✓	(1)		✓	✓	
190-GXT	OPEN	2000	12.75	✓	(1)		✓	✓	
190-DXT	OPEN	2000	12.75	✓	(1)		✓	✓	
200	OPEN	2300	13.25	✓	(1)		✓	✓	
210	OPEN	2000	18			✓			✓
220	OPEN	2000	18			✓			✓
440	OPEN	2000	20			✓			✓
5015	OPEN	1990	3.4						
5020	OPEN	1900	5.4	✓					
5030	OPEN	1900	5.4	✓					
5040	OPEN	2133	5.75	✓					
5045	OPEN	2200	6.25	✓					
5050	OPEN	2200	6.25	✓					
6040	OPEN	2300	7	✓			✓		
6060	OPEN	2300	10	✓	(1)		✓	✓	
6070	OPEN	2375	11.5	✓	(1)		✓	✓	
6080	OPEN	2300	10	✓	(1)		✓	✓	
6140	OPEN	1900	N.A.						
7000	OPEN	2400	15		✓		✓	✓	
7010 (2)	LS CLOSED	2500	17	✓			✓	✓	
7020 (2)	LS CLOSED	2500	17	✓			✓	✓	
7030 (2)	LS CLOSED	2500	17	✓			✓	✓	
7040 (2)	LS CLOSED	2500	17	✓			✓	✓	
7045 (2)	LS CLOSED	2500	17	✓			✓	✓	
7050 (2)	LS CLOSED	2500	17	✓			✓	✓	
7060 (2)	LS CLOSED	2500	17	✓			✓	✓	
7060-PS (2)	LS CLOSED	2500	17	✓			✓	✓	
7080 (2)	LS CLOSED	2500	18	✓			✓	✓	
7580 (2)	LS CLOSED	2500	18	✓			✓	✓	
8010 (2)	LS CLOSED	2500	17	✓			✓	✓	
8030 (2)	LS CLOSED	2500	17	✓			✓	✓	
8050 (2)	LS CLOSED	2500	17	✓			✓	✓	
8070 (2)	LS CLOSED	2500	18	✓			✓	✓	
8550 (2)	LS CLOSED	2500	18	✓			✓	✓	
4W 220 (2)	LS CLOSED	2500	20	✓			✓	✓	
4W 305 (2)	LS CLOSED	2500	20	✓			✓	✓	

(1) Select model FMC-HYD-210 when pumping pressures between 60 and 100 PSI are required.
 (2) This system is set up similar to a PC closed system.



ACE PUMP MODEL RECOMMENDATION

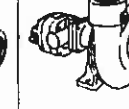
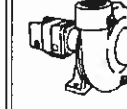
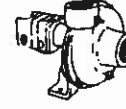
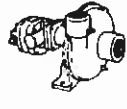
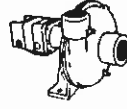
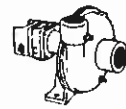

	Open or Closed Center System	Maximum Pressure Remote Outlets	Maximum Flow Remote Outlets US GPM	ACE PUMP MODEL RECOMMENDATION					
				1 X 1 SERIES			1 x 1 SERIES	2 x 1 SERIES	
				FMC-HYD-204	FMC-HYD-210	FMC-HYD-310	FMC-150-HYD-206	FMC-200-HYD-210 FMC-200-HYD-304	FMC-200-HYD-310
470	OPEN	1550	8.6	✓	(1)		✓	✓	
570	OPEN	1550	9.3	✓	(1)		✓	✓	
770	OPEN	1550	16		✓		✓	✓	
870	OPEN	1550	16		✓		✓	✓	
970	OPEN	1900	16		✓		✓	✓	
1070	OPEN	2100	16		✓		✓	✓	
1090	OPEN	2250	16		✓		✓	✓	
1170	OPEN	2250	16		✓		✓	✓	
1175	OPEN	2250	16		✓		✓	✓	
1190	OPEN	2200	7.25	✓			✓		
1194	OPEN	2200	7.25	✓		✓			✓
1270	OPEN	2200	20			✓			
1290	OPEN	2200	7.25	✓					
1294	OPEN	2200	7.25	✓					
1370	OPEN	2200	20			✓			✓
1390	OPEN	2200	15.3		✓		✓	✓	
1394	OPEN	2200	15.3		✓		✓	✓	
1470	OPEN	2200	16		✓		✓	✓	
1490	OPEN	2200	15.3		✓		✓	✓	
1494	OPEN	2200	15.3		✓		✓	✓	
1570	OPEN	2200	20			✓			✓
1594	OPEN	2200	20.1			✓			✓
1690	OPEN	2200	20.1			✓			✓
1896	LS CLOSED	2250	22		✓		✓	✓	
2090	LS CLOSED	2250	22		✓		✓	✓	
2094	LS CLOSED	2250	22		✓		✓	✓	
2096	LS CLOSED	2250	22		✓		✓	✓	
2290	LS CLOSED	2250	22		✓		✓	✓	
2294	LS CLOSED	2250	22		✓		✓	✓	
2390	LS CLOSED	2250	24		✓		✓	✓	
2394	LS CLOSED	2250	24		✓		✓	✓	
2470	OPEN	2050	17			✓			✓
2590	LS CLOSED	2250	24		✓		✓	✓	
2594	LS CLOSED	2250	24		✓		✓	✓	
2670	OPEN	2050	17			✓			✓
2870	OPEN	2050	22			✓			✓
3294	LS CLOSED	2250	22		✓		✓	✓	
3394	LS CLOSED	2250	24		✓		✓	✓	
3594	LS CLOSED	2250	24		✓		✓	✓	
4490	LS CLOSED	2250	24		✓		✓	✓	
4494	LS CLOSED	2250	24		✓		✓	✓	
4690	LS CLOSED	2250	24		✓		✓	✓	
4694	LS CLOSED	2250	24		✓		✓	✓	
4890	LS CLOSED	2250	24		✓		✓	✓	
4894	LS CLOSED	2250	24		✓		✓	✓	
4994	LS CLOSED	2250	30		✓		✓	✓	

(1) Select model FMC-HYD-210 when pumping pressures between 60 and 100 PSI are required.



ACE PUMP MODEL RECOMMENDATION

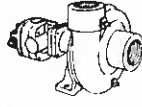
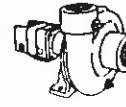
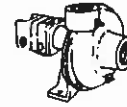
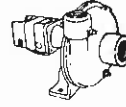

Open or Closed Center System

Maximum Pressure Remote Outlets

Maximum Flow Remote Outlets US GPM

1 X 1 SERIES

1 x 1 SERIES

2 x 1 SERIES

FMC-HYD-204

FMC-HYD-210

FMC-HYD-310

FMC-150-HYD-206

FMC-200-HYD-210
FMC-200-HYD-304

FMC-200-HYD-310



235	OPEN	N.A.	3.4						
245	OPEN	N.A.	4.8	✓					
265	OPEN	N.A.	5.7	✓					
275	OPEN	N.A.	7.3	✓			✓		
385	OPEN	2500	11.3	✓	(1)		✓	✓	
395	OPEN	2500	11.3	✓	(1)		✓	✓	
485	OPEN	2500	12.6	✓	(1)		✓	✓	
495	OPEN	2500	12.6	✓	(1)		✓	✓	
585	OPEN	2500	12.1/14.3	✓	✓		✓	✓	
595	OPEN	2500	12.1/14.3	✓	✓		✓	✓	
685	OPEN	2500	12.7/15.1		✓			✓	
695	OPEN	2500	12.7/15.1		✓			✓	
885	OPEN	2500	12.7/15.1		✓			✓	
895	OPEN	2500	12.7/15.1		✓			✓	
995	OPEN	2500	12.7/15.1		✓			✓	
1394	OPEN	2300	15.3		✓			✓	
1494	OPEN	2300	15.3		✓			✓	
1594	OPEN	2300	20.1			✓			✓
1896	LS CLOSED	2250	23		✓		✓	✓	
2096	LS CLOSED	2250	23		✓		✓	✓	
3220	OPEN	2500	14.7/16.9		(2)			(2)	
3230	OPEN	2500	15.3/17.7		(2)			(2)	
4210	OPEN	2500	16.1/18.4			✓			✓
4230	OPEN	2500	16.1/18.4			✓			✓
4240	OPEN	2500	16.1/18.4			✓			✓
4494	LS CLOSED	2250	24		✓		✓	✓	
4694	LS CLOSED	2250	24		✓		✓	✓	
4894	LS CLOSED	2250	24		✓		✓	✓	
4994	LS CLOSED	2650	28		✓		✓	✓	
5120	LS CLOSED	2400	17		✓		✓	✓	
5130	LS CLOSED	2400	17		✓		✓	✓	
5140	LS CLOSED	2400	17		✓		✓	✓	
5220	LS CLOSED	2400	17		✓		✓	✓	
5230	LS CLOSED	2400	17		✓		✓	✓	
5240	LS CLOSED	2400	17		✓		✓	✓	
5250	LS CLOSED	2400	17		✓		✓	✓	
7110	LS CLOSED	2300	22		✓		✓	✓	
7120	LS CLOSED	2300	22		✓		✓	✓	
7130	LS CLOSED	2300	22		✓		✓	✓	
7140	LS CLOSED	2300	22		✓		✓	✓	
7150	LS CLOSED	2300	22		✓		✓	✓	
7210	LS CLOSED	2300	22		✓		✓	✓	
7220	LS CLOSED	2300	22		✓		✓	✓	
7230	LS CLOSED	2300	22		✓		✓	✓	
7240	LS CLOSED	2300	22		✓		✓	✓	
7250	LS CLOSED	2300	22		✓		✓	✓	
8910	LS CLOSED	2800	29		✓		✓	✓	
8920	LS CLOSED	2800	29		✓		✓	✓	
8930	LS CLOSED	2800	29		✓		✓	✓	
8940	LS CLOSED	2800	29		✓		✓	✓	
8950	LS CLOSED	2800	29		✓		✓	✓	
9110 PUMA	LS CLOSED	2500	27		✓		✓	✓	
9130 WILDCAT	LS CLOSED	2500	27		✓		✓	✓	
9150 COUGAR	LS CLOSED	2500	27		✓		✓	✓	
9170	LS CLOSED	2500	27		✓		✓	✓	
9180	LS CLOSED	2500	27		✓		✓	✓	
9210	LS CLOSED	2500	27		✓		✓	✓	
9230	LS CLOSED	2500	27		✓		✓	✓	
9240	LS CLOSED	2500	27		✓		✓	✓	
9250	LS CLOSED	2500	27		✓		✓	✓	

Case IH (Continued)	Open or Closed Center System	Maximum Pressure Remote Outlets	Maximum Flow Remote Outlets US GPM	1 X 1 SERIES			1 x 1 SERIES	2 x 1 SERIES	
				FMC-HYD-204	FMC-HYD-210	FMC-HYD-310	FMC-150-HYD-208	FMC-200-HYD-210 FMC-200-HYD-304	FMC-200-HYD-310
9260	LS CLOSED	2500	27		✓		✓	✓	
9270	LS CLOSED	2500	27		✓		✓	✓	
9280	LS CLOSED	2500	27		✓		✓	✓	
9310	LS CLOSED	2900	27		✓		✓	✓	
9330	LS CLOSED	2900	28		✓		✓	✓	
9350	LS CLOSED	2900	30		✓		✓	✓	
9370	LS CLOSED	2900	30		✓		✓	✓	
9380	LS CLOSED	2900	30		✓		✓	✓	
9390	LS CLOSED	2900	30		✓		✓	✓	
C50	OPEN	2500	16		✓			✓	
CX50	OPEN	2500	16		✓			✓	
C60	OPEN	2500	16		✓			✓	
C80	OPEN	2500	16		✓			✓	
C90	OPEN	2500	16		✓			✓	
C100	OPEN	2500	16		✓			✓	
MX100	LS CLOSED	2950	25		✓		✓	✓	
MX110	LS CLOSED	2950	25		✓		✓	✓	
MX120	LS CLOSED	2950	25		✓		✓	✓	
MX135	LS CLOSED	2950	25		✓		✓	✓	

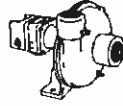
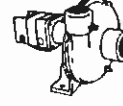
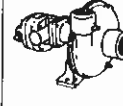
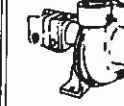
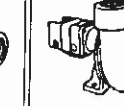
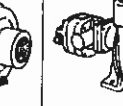
(1) Select model FMC-HYD-210 when pumping pressures between 60 and 100 PSI are required. (2) Tractors with open center hydraulic systems 16 GPM and larger use the -310 motors only.

CAT	Open or Closed Center System	Maximum Pressure Remote Outlets	Maximum Flow Remote Outlets US GPM	ACE PUMP MODEL RECOMMENDATION					
									
				1 X 1 SERIES			1 x 1 SERIES	2 x 1 SERIES	
				FMC-HYD-204	FMC-HYD-210	FMC-HYD-310	FMC-150-HYD-208	FMC-200-HYD-210 FMC-200-HYD-304	FMC-200-HYD-310
35	LS CLOSED	2500	24		✓		✓	✓	
45	LS CLOSED	2500	24		✓		✓	✓	
55	LS CLOSED	2750	31.5		✓		✓	✓	
65B(1)	LS CLOSED	2550	27.5		✓		✓	✓	
65C	LS CLOSED	2550	27.5		✓		✓	✓	
65D	LS CLOSED	2750	27.5		✓		✓	✓	
65E	LS CLOSED	2900	30		✓		✓	✓	
70C	LS CLOSED	2500	27.5	✓	✓		✓	✓	
75C	LS CLOSED	2550	27.5		✓		✓	✓	
75D	LS CLOSED	2750	27.5		✓		✓	✓	
75E	LS CLOSED	2900	30		✓		✓	✓	
85C	LS CLOSED	2500	27.5	✓	✓		✓	✓	
85D	LS CLOSED	2750	27.5		✓		✓	✓	
85E	LS CLOSED	2900	30		✓		✓	✓	
95E	LS CLOSED	2900	30		✓		✓	✓	

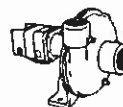
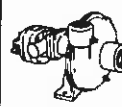
(1) Hydraulic oil coolers are not standard on this tractor model. An oil cooler is required for continuous duty sprayer pump operation.

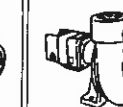
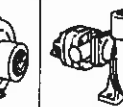
JOHN DEERE	Open or Closed Center System	Maximum Pressure Remote Outlets	Maximum Flow Remote Outlets US GPM	ACE PUMP MODEL RECOMMENDATION					
									
				1 1/4 X 1 SERIES			1 1/2 x 1 1/4 SERIES	2 x 1 1/4 SERIES	
				FMC-HYD-204	FMC-HYD-210	FMC-HYD-310	FMC-150-HYD-208	FMC-200-HYD-210 FMC-200-HYD-304	FMC-200-HYD-310
1020	PC CLOSED	2000	6.5	✓					
1050	OPEN	2000	5.8	✓					
1250	OPEN	2000	15.9		✓		✓	✓	
1450	OPEN	2250	15.2		✓		✓	✓	
1520	PC CLOSED	2000	6.5	✓					

John Deere (Continued)	Open or Closed Center System	Maximum Pressure Remote Outlets	Maximum Flow Remote Outlets US GPM	1 X 1 SERIES			1 x 1 SERIES	2 x 1 SERIES	
				FMC-HYD-204	FMC-HYD-210	FMC-HYD-310	FMC-150-HYD-206	FMC-200-HYD-210 FMC-200-HYD-304	FMC-200-HYD-310
1530	PC CLOSED	2250	6.5/12	✓			✓		
1850	OPEN	2250	14.5		✓		✓	✓	
2020	PC CLOSED	2250	6.5/12	✓			✓		
2030	PC CLOSED	2000	6.5	✓					
2040(SN to 266749)	OPEN	2100	6.5	✓				✓	
2040(SN to 266750 up)	PC CLOSED	1825	12	✓			✓	✓	
2150	PC CLOSED	2250	12.5	✓			✓	✓	
2155	PC CLOSED	2320	13	✓			✓	✓	
2240	PC CLOSED	2250	12	✓			✓	✓	
2255	PC CLOSED	2250	13	✓			✓	✓	
2350	PC CLOSED	2250	12.5/22	✓			✓	✓	
2355	PC CLOSED	2320	13/23	✓			✓	✓	
2440	PC CLOSED	2250	12/21.5	✓			✓	✓	
2520	PC CLOSED	2000	13	✓			✓	✓	
2550	PC CLOSED	2250	12.5/22	✓			✓	✓	
2555	PC CLOSED	2350	13/23	✓			✓	✓	
2630	PC CLOSED	2250	12/14	✓			✓	✓	
2640	PC CLOSED	2250	12/21.5	✓			✓	✓	
2750	PC CLOSED	2250	12.5/22	✓			✓	✓	
2755	PC CLOSED	2320	13/23	✓			✓	✓	
2840	PC CLOSED	2250	18	✓			✓	✓	
2855	PC CLOSED	2320	21	✓			✓	✓	
2940	PC CLOSED	2250	21.5	✓			✓	✓	
2950	PC CLOSED	2250	22	✓			✓	✓	
2955	PC CLOSED	2320	21	✓			✓	✓	
3020	PC CLOSED	2000	14	✓			✓	✓	
3055	PC CLOSED	2320	21	✓			✓	✓	
3150	PC CLOSED	2320	22	✓			✓	✓	
3155	PC CLOSED	2320	22	✓			✓	✓	
3255	PC CLOSED	2320	22	✓			✓	✓	
4000	PC CLOSED	2000	14	✓			✓	✓	
4020	PC CLOSED	2000	14	✓			✓	✓	
4030	PC CLOSED	2250	18	✓			✓	✓	
4040	PC CLOSED	2200	20	✓			✓	✓	
4050	PC CLOSED	2300	23	✓			✓	✓	
4055	PC CLOSED	2530	26.5	✓			✓	✓	
4230	PC CLOSED	2250	18	✓			✓	✓	
4240	PC CLOSED	2200	20	✓			✓	✓	
4250	PC CLOSED	2300	23	✓			✓	✓	
4250 HIGH CROP	PC CLOSED	2320	26	✓			✓	✓	
4255	PC CLOSED	2530	26.5	✓			✓	✓	
4320	PC CLOSED	2000	14	✓			✓	✓	
4420	PC CLOSED	2530	18	✓			✓	✓	
4430	PC CLOSED	2250	18	✓			✓	✓	
4440	PC CLOSED	2200	20	✓			✓	✓	
4450	PC CLOSED	2300	23	✓			✓	✓	
4455	PC CLOSED	2530	26.5	✓			✓	✓	
4555	PC CLOSED	2530	30	✓			✓	✓	
4560	PC CLOSED	2320	26.5	✓			✓	✓	
4620	PC CLOSED	2000	15	✓			✓	✓	
4630	PC CLOSED	2250	18	✓			✓	✓	
4640	PC CLOSED	2200	20	✓			✓	✓	
4650	PC CLOSED	2300	26.5	✓			✓	✓	
4755	PC CLOSED	2530	30	✓			✓	✓	
4760	PC CLOSED	2530	30	✓			✓	✓	
4840	PC CLOSED	2200	20	✓			✓	✓	
4850	PC CLOSED	2300	26.5	✓			✓	✓	
4955	PC CLOSED	2530	30	✓			✓	✓	
4960	PC CLOSED	2530	30	✓			✓	✓	
5020	PC CLOSED	2000	15	✓			✓	✓	
5200	OPEN	2750	11.4	✓	✓		✓	✓	
5300	OPEN	2750	11.4	✓	✓		✓	✓	
5400	OPEN	2750	11.4	✓	✓		✓	✓	
6030	PC CLOSED	2000	15	✓			✓	✓	
6200	LS CLOSED	2900	16/25		✓		✓	✓	

John Deere (Continued)	Open or Closed Center System	Maximum Pressure Remote Outlets	Maximum Flow Remote Outlets US GPM	1 X 1 SERIES			1 x 1 SERIES	2 x 1 SERIES	
				FMC-HYD-204	FMC-HYD-210	FMC-HYD-310	FMC-150-HYD-206	FMC-200-HYD-210 FMC-200-HYD-304	FMC-200-HYD-310
6300	LS CLOSED	2900	16/25		✓		✓	✓	
6400	LS CLOSED	2900	16/25		✓		✓	✓	
6405	LS CLOSED	2500	17.5	✓			✓	✓	
6500	PC CLOSED	2900	18.8	✓			✓	✓	
6605	LS CLOSED	2500	17.5	✓			✓	✓	
7010	LS CLOSED	2900	35	✓	✓		✓	✓	
7020	PC CLOSED	2000	14	✓			✓	✓	
7200	LS CLOSED	2900	25	✓	✓		✓	✓	
7210	LS CLOSED	2900	25	✓	✓		✓	✓	
7400	LS CLOSED	2900	25	✓	✓		✓	✓	
7405	LS CLOSED	2750	17.5	✓			✓	✓	
7410	LS CLOSED	2900	25	✓			✓	✓	
7520	PC CLOSED	2000	14	✓			✓	✓	
7600	LS CLOSED	2900	25	✓	✓		✓	✓	
7610	LS CLOSED	2900	25	✓	✓		✓	✓	
7700	LS CLOSED	2900	25	✓	✓		✓	✓	
7710	LS CLOSED	2900	35	✓	✓		✓	✓	
7800	LS CLOSED	2900	25	✓	✓		✓	✓	
7810	LS CLOSED	2900	25	✓	✓		✓	✓	
8100	LS CLOSED	2900	30	✓	✓		✓	✓	
8200	LS CLOSED	2900	30	✓	✓		✓	✓	
8300	LS CLOSED	2900	30	✓	✓		✓	✓	
8400	LS CLOSED	2900	30	✓	✓		✓	✓	
8430	PC CLOSED	2250	18	✓			✓	✓	
8440	PC CLOSED	2250	18	✓			✓	✓	
8450	PC CLOSED	2250	28.5	✓			✓	✓	
8560	PC CLOSED	2530	33.3	✓			✓	✓	
8570	PC CLOSED	2530	33	✓			✓	✓	
8630	PC CLOSED	2250	18	✓			✓	✓	
8640	PC CLOSED	2250	18	✓			✓	✓	
8650	PC CLOSED	2250	28.5	✓			✓	✓	
8760	PC CLOSED	2530	33.3	✓			✓	✓	
8770	PC CLOSED	2530	33	✓			✓	✓	
8850	PC CLOSED	2250	44.5	✓			✓	✓	
8870	PC CLOSED	2530	33	✓			✓	✓	
8960	PC CLOSED	2530	33.3	✓			✓	✓	
8970	PC CLOSED	2530	33	✓			✓	✓	
9100	LS CLOSED	2900	33	✓	✓		✓	✓	
9200	LS CLOSED	2900	33	✓	✓		✓	✓	
9300	LS CLOSED	2900	33	✓	✓		✓	✓	
9400	LS CLOSED	2900	33	✓	✓		✓	✓	

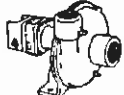
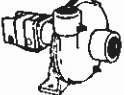
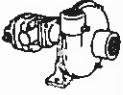
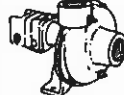
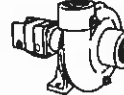
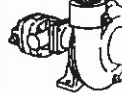
	Open or Closed Center System	Maximum Pressure Remote Outlets	Maximum Flow Remote Outlets US GPM	ACE PUMP MODEL RECOMMENDATION					
				  			 		
				1 X 1 SERIES			1 x 1 SERIES		2 x 1 SERIES
				FMC-HYD-204	FMC-HYD-210	FMC-HYD-310	FMC-150-HYD-206	FMC-200-HYD-210 FMC-200-HYD-304	FMC-200-HYD-310
4W305	LS CLOSED	2500	23		✓		✓	✓	
5215HST (2)	OPEN	1990	3.57						
5220HST (2)	OPEN	1990	3.57						
5220 (3)	OPEN	1985	5.15	✓					
5230 (3)	OPEN	1985	6.4	✓					
6240	OPEN	2538	7.5	✓			✓	✓	
6250	OPEN	2538	11	✓	(1)		✓	✓	
6260	OPEN	2538	11	✓	(1)		✓	✓	
6265	OPEN	2538	10.5	✓	(1)		✓	✓	
6275	OPEN	2538	10.5	✓	(1)		✓	✓	
7085	OPEN	2538	12.4		✓		✓	✓	
7110	OPEN	2538	15.3		✓		✓	✓	
7120	OPEN	2538	14.8		✓		✓	✓	
7145	OPEN	2538	18.2			✓	✓	✓	✓
8010	LS CLOSED	2500	22		✓		✓	✓	

Deutz Allis (Continued)	Open or Closed Center System	Maximum Pressure Remote Outlets	Maximum Flow Remote Outlets US GPM	1 X 1 SERIES			1 x 1 SERIES	2 x 1 SERIES	
				FMC-HYD-204	FMC-HYD-210	FMC-HYD-310	FMC-150-HYD-206	FMC-200-HYD-210 FMC-200-HYD-304	FMC-200-HYD-310
8030	LS CLOSED	2500	22		✓		✓	✓	
8050	LS CLOSED	2500	22		✓		✓	✓	
8070	LS CLOSED	2500	22		✓		✓	✓	
8550	LS CLOSED	2500	23		✓		✓	✓	
9130	PC CLOSED	2275	23	✓			✓	✓	
9150	PC CLOSED	2275	24	✓			✓	✓	
9170	PC CLOSED	2275	23	✓			✓	✓	
9190	PC CLOSED	2500	23	✓			✓	✓	

(1) Select model FMC-HYD-210 when pumping pressures between 60 and 100 PSI are required. (2) These hydraulic systems are not suitable for operating a sprayer pump.
(3) Hydraulic oil coolers are not standard on these tractor models. An oil cooler is required for continuous duty sprayer pump operation.

ACE PUMP MODEL RECOMMENDATION

Ford NEW HOLLAND	Open or Closed Center System	Maximum Pressure Remote Outlets	Maximum Flow Remote Outlets US GPM	ACE PUMP MODEL RECOMMENDATION					
				1 X 1 SERIES			1 x 1 SERIES	2 x 1 SERIES	
				FMC-HYD-204	FMC-HYD-210	FMC-HYD-310	FMC-150-HYD-206	FMC-200-HYD-210 FMC-200-HYD-304	FMC-200-HYD-310
276	LS CLOSED	2800	27.6		✓		✓	✓	
756	LS CLOSED	2500	25.2		✓		✓	✓	
836	LS CLOSED	2500	25.2		✓		✓	✓	
846	LS CLOSED	2500	25.2		✓		✓	✓	
856	LS CLOSED	2500	25.2		✓		✓	✓	
876	LS CLOSED	2500	25.2		✓		✓	✓	
936	LS CLOSED	2400	24.5		✓		✓	✓	
946	LS CLOSED	2400	24.5		✓		✓	✓	
956	LS CLOSED	2400	24.5		✓		✓	✓	
976	LS CLOSED	2400	24.5		✓		✓	✓	
1000	OPEN	1400	4.2	✓					
1100	OPEN	1849	2.9	✓					
1110	OPEN	1849	4.1	✓					
1120	OPEN	1850	4.7	✓					
1156	LS CLOSED	2500	27		✓		✓	✓	
1200	OPEN	1849	2.9	✓					
1210	OPEN	1849	4.3	✓					
1220	OPEN	1850	4.7	✓					
1300	OPEN	2133	4.0	✓					
1310	OPEN	2133	6.3	✓					
1320	OPEN	2133	6.4	✓					
1500	OPEN	2133	4.0	✓					
1510	OPEN	2133	6.6	✓					
1520	OPEN	2133	6.4	✓					
1600	OPEN	1400	4.2	✓					
1700	OPEN	2133	5.3	✓			✓		
1710	OPEN	2133	7.8	✓			✓		
1720	OPEN	2133	7.8	✓			✓		
1900	OPEN	2133	5.9	✓			✓		
1910	OPEN	2133	8.6	✓			✓		
1920	OPEN	2133	7.8	✓			✓		
2000	OPEN	2500	4	✓			✓		
2110	OPEN	2133	6.6	✓			✓	✓	
2120	OPEN	2500	9.3	✓		✓	✓	✓	
2310	(1) (3)	2500	7.7/13.6	✓		✓	✓	✓	
2600	OPEN	2100	8.5	✓		(2)	✓	✓	
2610	(1) (3)	2500	7.7/13.6	✓		✓	✓	✓	
2810	(1) (3)	2500	8.5/14.1	✓		✓	✓	✓	
2910	(1) (3)	2500	8.5/14.1	✓		✓	✓	✓	
3000	OPEN	2500	5	✓		✓	✓	✓	
3230	(3)	2500	8.5/14.1	✓		✓	✓	✓	
3430	(3)	2500	8.5/14.1	✓		✓	✓	✓	
3600	OPEN	2500	8.5	✓		(2)	✓	✓	
3610	(1) (3)	2500	7.7/13.6	✓		✓	✓	✓	
3830	OPEN	2610	11	✓		✓	✓	✓	

Ford New Holland (Continued)	Open or Closed Center System	Maximum Pressure Remote Outlets	Maximum Flow Remote Outlets US GPM	1 X 1 SERIES			1 x 1 SERIES	2 x 1 SERIES	
				FMC-HYD-204	FMC-HYD-210	FMC-HYD-310	FMC-150-HYD-206	FMC-200-HYD-210 FMC-200-HYD-304	FMC-200-HYD-310
3910	(1) (3)	2500	8.5/14.1		✓		✓	✓	
3930	(3)	2500	8.5/14.1		✓		✓	✓	
4000	OPEN	2500	5	✓	✓		✓	✓	
4030	OPEN	2610	11	✓	✓		✓	✓	
4100	OPEN	2500	8.5	✓	(2)		✓	✓	
4110	OPEN	2500	8.5	✓			✓	✓	
4230	OPEN	2610	11	✓	✓		✓	✓	
4430	OPEN	2610	11	✓	✓		✓	✓	
4600	OPEN	2100	8.5	✓	(2)		✓	✓	
4610	(1) (3)	2500	8.5/14.1		✓		✓	✓	
4630	(3)	2500	8.5/14.1		✓		✓	✓	
4835	(3)	2750	14.5		✓		✓	✓	
5000	OPEN	2500	6	✓	✓		✓	✓	
5030	OPEN	2610	11	✓	✓		✓	✓	
5600	OPEN	2500	9.7	✓	(2)		✓	✓	
5610	(3)	2500	9.7/18.2		✓		✓	✓	
5610 (SPECIAL)	(3)	2500	18		✓		✓	✓	
5635	(3)	2750	14.5		✓		✓	✓	
5640 S, SL	(3)	2500	18		✓		✓	✓	
5640 SLE	LS CLOSED	2500	21		✓		✓	✓	
5900	OPEN	2100	9.0		✓		✓	✓	
6600	OPEN	2500	9.7	✓	(2)		✓	✓	
6610	(3)	2500	9.7		✓		✓	✓	
6610 (SPECIAL)	(3)	2500	18		✓		✓	✓	
6635	(3)	2750	14.5		✓		✓	✓	
6640 S, SL	(3)	2500	18		✓		✓	✓	
6640 SLE	LS CLOSED	2500	21		✓		✓	✓	
6700	OPEN	2500	9.7	✓	(2)		✓	✓	
6710	(3)	2500	9.7		✓		✓	✓	
7000	OPEN	2500	6.0	✓	✓		✓	✓	
7600	OPEN	2500	9.7	✓	(2)		✓	✓	
7610	(3)	2500	9.7/18.2		✓		✓	✓	
7635	(3)	2750	14.5		✓		✓	✓	
7700	OPEN	2500	9.7	✓	✓		✓	✓	
7710	(3)	2500	9.7/18.2		✓		✓	✓	
7740 S, SL	(3)	2500	18		✓		✓	✓	
7740 SLE	LS CLOSED	2500	20		✓		✓	✓	
7810	(3)	2500	9.7/18.2		✓		✓	✓	
7840 SL	(3)	2500	17.4		✓		✓	✓	
7840 SLE	LS CLOSED	2500	20		✓		✓	✓	
8000	OPEN	2500	12	✓	(2)		✓	✓	
8160	LS CLOSED	2750	20		✓		✓	✓	
8210	(3)	2500	10.6		✓		✓	✓	
8240 SLE	LS CLOSED	2500	20		✓		✓	✓	
8260	LS CLOSED	2750	20		✓		✓	✓	
8340 SLE	LS CLOSED	2500	20		✓		✓	✓	
8360	LS CLOSED	2750	20		✓		✓	✓	
8530	(3)	2500	29		✓		✓	✓	
8560	LS CLOSED	2750	20		✓		✓	✓	
8600	OPEN	2500	15.5		✓		✓	✓	
8630	(3)	2500	29		✓		✓	✓	
8670	LS CLOSED	2750	24		✓		✓	✓	
8730	(3)	2500	29		✓		✓	✓	
8770	LS CLOSED	2750	24		✓		✓	✓	
8830	(3)	2500	29		✓		✓	✓	
8870	LS CLOSED	2750	24		✓		✓	✓	
8970	LS CLOSED	2750	24		✓		✓	✓	
9000	OPEN	2500	16		✓		✓	✓	
9030	LS CLOSED	2400	25		✓		✓	✓	
9280	LS CLOSED	2400	25/30		✓		✓	✓	
9282	LS CLOSED	2900	30		✓		✓	✓	
9480	LS CLOSED	2400	25/30		✓		✓	✓	
9482	LS CLOSED	2900	30		✓		✓	✓	
9600	OPEN	2500	15.5		✓		✓	✓	
9680	LS CLOSED	2400	25/30		✓		✓	✓	

Ford New Holland (Continued)	Open or Closed Center System	Maximum Pressure Remote Outlets	Maximum Flow Remote Outlets US GPM	1 X 1 SERIES			1 x 1 SERIES	2 x 1 SERIES	
				FMC-HYD-204	FMC-HYD-210	FMC-HYD-310	FMC-150-HYD-206	FMC-200-HYD-210 FMC-200-HYD-304	FMC-200-HYD-310
9682	LS CLOSED	2900	30		✓		✓	✓	
9700	OPEN	2500	15.5		✓		✓	✓	
9880	LS CLOSED	2400	25/30		✓		✓	✓	
9882	LS CLOSED	2900	30		✓		✓	✓	
TS90 8X2	(3)	2500	18		✓		✓	✓	
TS90 16X16	LS CLOSED	2500	21		✓		✓	✓	
TS100 8X2	(3)	2500	18		✓		✓	✓	
TS100 16X16	LS CLOSED	2500	21		✓		✓	✓	
TS110 8X2	(3)	2500	18		✓		✓	✓	
TS110 16X16	LS CLOSED	2500	21		✓		✓	✓	
TW5 (4)	OPEN	2500	16		✓		✓	✓	
TW5 (5)	(3)	2500	25.4		✓		✓	✓	
TW10	OPEN	2500	16.2		✓		✓	✓	
TW15 (4)	OPEN	2500	15.3		✓		✓	✓	
TW15 (5)	(3)	2500	24.3		✓		✓	✓	
TW20	OPEN	2500	15.5		✓		✓	✓	
TW25 (4)	OPEN	2500	15.3		✓		✓	✓	
TW25 (5)	(3)	2500	24.3		✓		✓	✓	
TW30	OPEN	2500	20			✓	✓		✓
TW35 (4)	OPEN	2500	20			✓			✓
TW35 (5)	(3)	2500	29		✓		✓	✓	
COUNTRY SUPER 4	OPEN	2500	6	✓					
COUNTRY SUPER 6	OPEN	2500	6.3	✓					
FW20	OPEN	2250	20			✓			✓
FW30	OPEN	2250	20			✓			✓
FW40	OPEN	2250	20			✓			✓
FW60	OPEN	2250	20			✓			✓

General Note: Do not tie hydraulic lever in any active position.

(1) Series 10 tractors with three cylinder engines can have either OPEN center or a type of CLOSED center hydraulic systems. The type system is most easily identified by the location of the hydraulic valves.

On OPEN center systems, the hydraulic valves are located under the seat with the hoses running to the couplers in the rear.

On CLOSED center systems, the hydraulic valves are located at the rear of the tractor.

(2) Select model FMC-HYD-210 when pumping pressures between 60 and 100 PSI are required.

(3) Ford's CLOSED hydraulic system has constant displacement pumps and senses the pressure drop between the combining valve and the remote ports. Most other closed centered systems have a variable displacement pump. Contact Ford New Holland before operating a hydraulic driven sprayer pump on a tractor with this type hydraulic system. An auxiliary oil cooler may be required for continuous duty sprayer pump operation.





(4) Manufactured prior to July 1985.

(5) Manufactured after July 1985.

INTERNATIONAL HARVESTER	Open or Closed Center System	Maximum Pressure Remote Outlets	Maximum Flow Remote Outlets US GPM	ACE PUMP MODEL RECOMMENDATION						
				1 X 1 SERIES			1 x 1 SERIES	2 x 1 SERIES		
				FMC-HYD-204	FMC-HYD-210	FMC-HYD-310	FMC-150-HYD-206	FMC-200-HYD-210 FMC-200-HYD-304	FMC-200-HYD-310	
140	OPEN	1200	5	✓						
234	OPEN	1920	3.4	✓						
244	OPEN	1995	4.1	✓						
254	OPEN	1995	4.2	✓						
274	OPEN	1850	5.9	✓						
284	OPEN	1850	5.9	✓						
354	OPEN	1200	4.9	✓						
364	OPEN	2400	9	✓	(1)		✓	✓		
384	OPEN	2400	9	✓	(1)		✓	✓		
454	OPEN	2300	6	✓						
464	OPEN	2500	10.5	✓	(1)		✓	✓		
484	OPEN	2000	12	✓	(1)		✓	✓		
544	OPEN	1600	15	✓	(1)		✓	✓		
574	OPEN	2300	9.5	✓	(1)		✓	✓		
584	OPEN	2000	12.5	✓	(1)		✓	✓		

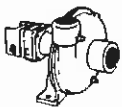
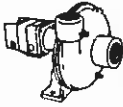
International Harvester (Continued)	Open or Closed Center System	Maximum Pressure Remote Outlets	Maximum Flow Remote Outlets US GPM	1 X 1 SERIES			1 x 1 SERIES	2 x 1 SERIES	
				FMC-HYD-204	FMC-HYD-210	FMC-HYD-310	FMC-150-HYD-206	FMC-200-HYD-210 FMC-200-HYD-304	FMC-200-HYD-310
604	OPEN	2000	13	✓			✓	✓	
656	OPEN	2000	15		✓		✓	✓	
664	OPEN	1600	16		✓		✓	✓	
666	OPEN	1350	15		✓		✓	✓	
674	OPEN	2300	10.5	✓	(1)		✓	✓	
684	OPEN	2500	10.5	✓	(1)		✓	✓	
686	OPEN	1550	15		✓		✓	✓	
756	OPEN	1550	12	✓	(1)		✓	✓	
HYDRO 70	OPEN	1350	15		✓		✓	✓	
766	OPEN	2000	13	✓	(1)		✓	✓	
784	OPEN	2000	13	✓	(1)		✓	✓	
HYDRO 84	OPEN	2000	13	✓	(1)		✓	✓	
HYDRO 86	OPEN	1550	15		✓		✓	✓	
826	OPEN	2000	12	✓	(1)		✓	✓	
856	OPEN	2000	12	✓	(1)		✓	✓	
884	OPEN	2000	13	✓	(1)		✓	✓	
886 (2)	OPEN	2250	13	✓	(1)		✓	✓	
966	OPEN	2000	13	✓	(1)		✓	✓	
986 (2)	OPEN	2250	12	✓	(1)		✓	✓	
986 (3) (SN UO24000 up)	LS CLOSED	2650	18		✓		✓	✓	
HYDRO 100	OPEN	2000	13	✓	(1)		✓	✓	
HYDRO 186 (2)	OPEN	2250	12	✓	(1)		✓	✓	
HYDRO 186 (3) (SN UO12000 up)	LS CLOSED	2650	18		✓		✓	✓	
1026	OPEN	2000	12	✓	(1)		✓	✓	
1066	OPEN	2000	13	✓	(1)		✓	✓	
1086 (2)	OPEN	2450	13	✓	(1)		✓	✓	
1086 (3) (SN UO48000 up)	LS CLOSED	2650	18		✓		✓	✓	
1466	OPEN	2250	13	✓	(1)		✓	✓	
1486 (2)	OPEN	2450	13	✓	(1)		✓	✓	
1486 (3) (SN UO26000 up)	LS CLOSED	2650	18		✓		✓	✓	
1566	OPEN	2250	13	✓	(1)		✓	✓	
1568	OPEN	2250	13	✓	(1)		✓	✓	
1586 (2)	OPEN	2450	13	✓	(1)		✓	✓	
1586 (3) (SN UO21000 up)	LS CLOSED	2650	18		✓		✓	✓	
3088	OPEN	2000	12	✓	(1)		✓	✓	
3288	OPEN	2000	12	✓	(1)		✓	✓	
3388	LS CLOSED	2650	18		✓		✓	✓	
3488	LS CLOSED	2650	18		✓		✓	✓	
3588	LS CLOSED	2650	18		✓		✓	✓	
3688	LS CLOSED	2650	18		✓		✓	✓	
3788	LS CLOSED	2650	18		✓		✓	✓	
4166	OPEN	2000	18			✓			✓
4186	OPEN	2000	18			✓			✓
4366	OPEN	1800	16		✓		✓	✓	
4386	OPEN	2000	16		✓		✓	✓	
4568	OPEN	1800	16		✓		✓	✓	
4586 (2)	OPEN	2000	19			✓			✓
4786 (2)	OPEN	2000	19			✓			✓
5088	LS CLOSED	2650	26		✓		✓	✓	
5288	LS CLOSED	2650	26		✓		✓	✓	
5488	LS CLOSED	2650	26		✓		✓	✓	
6388	LS CLOSED	2650	18		✓		✓	✓	
6588	LS CLOSED	2650	18		✓		✓	✓	
6788	LS CLOSED	2650	18		✓		✓	✓	
7288	LS CLOSED	2650	26		✓		✓	✓	
7388	OPEN	2000	22			✓			✓
7488	LS CLOSED	2650	26		✓		✓	✓	
7588	OPEN	2000	22			✓			✓
7788	OPEN	2250	22			✓			✓

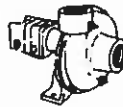
- (1) Select model FMC-HYD-210 when pumping pressures between 60 and 100 PSI are required.
(2) In the 86 Series tractors with open center systems, the hydraulic system was not designed for continuous hydraulic demand at the remote valves. These tractors will require the Ace Pump IHK-86 kit for sprayer pump operation. Refer to Ace form 4013-A for complete installation instructions. Reference the International Harvester Service Bulletin S-3436 dated March 31, 1977.
(3) Requires IHK-86 kit for operation.

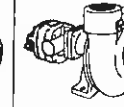
Massey Ferguson	Open or Closed Center System	Maximum Pressure Remote Outlets	Maximum Flow Remote Outlets US GPM	ACE PUMP MODEL RECOMMENDATION					
									
				1 X 1 SERIES			1 x 1 SERIES	2 x 1 SERIES	
				FMC-HYD-204	FMC-HYD-210	FMC-HYD-310	FMC-150-HYD-206	FMC-200-HYD-210 FMC-200-HYD-304	FMC-200-HYD-310
MF135	OPEN	2600	8	✓			✓		
MF150	OPEN	2600	8	✓			✓		
MF154	OPEN	2418	9.2	✓	(1)		✓		
MF165	OPEN	2600	8	✓			✓		
MF174	OPEN	2418	9.8	✓	(1)		✓		
MF175	OPEN	2600	8	✓			✓		
MF180	OPEN	2600	8	✓			✓		
MF184-4	OPEN	2418	7.4	✓			✓		
MF194	OPEN	2418	9.4	✓	(1)		✓		
MF203	OPEN	2600	8	✓			✓		
MF230	OPEN	2600	10	✓	(1)		✓		
MF231	OPEN	2540	4	✓			✓		
MF235	OPEN	3000	10	✓	(1)		✓		
MF240	OPEN	3000	4	✓			✓		
MF245	OPEN	3000	10	✓	(1)		✓		
MF250	OPEN	3000	4	✓			✓		
MF253	BOTH (2)	3000	9.5/13.5	✓			✓		
MF254	OPEN	2600	10	✓	(1)		✓		
MF255	OPEN	3000	10	✓	(1)		✓		
MF261	OPEN	3100	4.4	✓			✓		
MF270	BOTH (2)	3000	9.5/13.5	✓			✓		
MF274	OPEN	2418	9.8	✓	(1)		✓		
MF275	OPEN	3000	10	✓	(1)		✓		
MF283	PC CLOSED	3000	10	✓			✓		
MF285	OPEN	3000	10	✓	(1)		✓		
MF290	BOTH (2)	2400	9.5	✓			✓		
MF294	OPEN	2418	9.4	✓			✓		
MF298	OPEN	2400	9.5	✓			✓		
MF360	BOTH (2)	3000	9.5/13.5	✓			✓		
MF362	BOTH (2)	3000	9.5/13.5	✓			✓		
MF374	OPEN	2500	11.2	✓			✓		
MF375	BOTH (2)	3000	9.5/13.5	✓	✓		✓		
MF383	BOTH (2)	3000	9.5/13.5	✓			✓		
MF384	OPEN	2500	11.2	✓	✓		✓		
MF390	BOTH (2)	3000	9.5/13.5	✓			✓		
MF394	OPEN	2500	11.2	✓	✓		✓		
MF398	BOTH (2)	3000	9.5/13.5	✓			✓		
MF399	BOTH (2)	3000	9.5/13.5	✓			✓		
MF670	BOTH (2)	3000	9.5/13.5	✓			✓		
MF690	BOTH (2)	3000	9.5/13.5	✓			✓		
MF698	BOTH (2)	3000	9.5/13.5	✓			✓		
MF699	BOTH (2)	3000	9.5/13.5	✓			✓		
MF1085	OPEN	2600	10	✓	(1)		✓		
MF1100	PC CLOSED	2150	20	✓			✓		
MF1105	PC CLOSED	2150	20	✓			✓		
MF1130	PC CLOSED	2150	20	✓			✓		
MF1135	PC CLOSED	2150	20	✓			✓		
MF1150	PC CLOSED	2150	20	✓			✓		
MF1155	PC CLOSED	2150	20	✓			✓		
MF1500	OPEN	2400	20			✓			✓
MF1505	OPEN	2400	20			✓			✓
MF1800	OPEN	2400	20			✓			✓
MF1805	OPEN	2400	20			✓			✓
MF2675	OPEN	2250	16		✓			✓	
MF2705	OPEN	2250	16		✓			✓	
MF2745	OPEN	2250	16		✓			✓	
MF2775	OPEN	2250	16		✓			✓	
MF2805 (3)	OPEN	2250	16		✓			✓	
MF3050	OPEN	2610	13.2		✓			✓	
MF3060	OPEN	2610	13.2		✓			✓	



Massey Ferguson (Continued)	Open or Closed Center System	Maximum Pressure Remote Outlets	Maximum Flow Remote Outlets US GPM	1 X 1 SERIES			1 x 1 SERIES	2 x 1 SERIES	
				FMC-HYD-204	FMC-HYD-210	FMC-HYD-310	FMC-150-HYD-208	FMC-200-HYD-210 FMC-200-HYD-304	FMC-200-HYD-310
MF3070	OPEN	2610	13.2		✓		✓	✓	
MF3075	OPEN	2610	13.2		✓		✓	✓	
MF3090	OPEN	2610	13.2		✓		✓	✓	
MF3120	OPEN	2610	13.2		✓		✓	✓	
MF3140	OPEN	2610	13.2		✓		✓	✓	
MF3505	OPEN	2538	14		✓		✓	✓	
MF3525	OPEN	2538	14		✓		✓	✓	
MF3545	OPEN	2538	13.2		✓		✓	✓	
MF3630	OPEN	2538	14.4		✓		✓	✓	
MF3645	OPEN	2418	9.5	✓			✓		
MF3650	OPEN	2538	14.4		✓		✓	✓	
MF3660	OPEN	2538	14.4		✓		✓	✓	
MF3670	OPEN	2538	14.4		✓		✓	✓	
MF3680	OPEN	2538	14.4		✓		✓	✓	
MF3690	OPEN	2538	14.4		✓		✓	✓	
MF3745	OPEN	2418	9.5	✓			✓		
MF3845	OPEN	2418	9.5	✓			✓		
MF3945	OPEN	2418	9.5	✓			✓		
MF4225	OPEN	3046	10	✓	✓		✓	✓	
MF4235	OPEN	3046	10	✓	✓		✓	✓	
MF4243	OPEN	3046	10	✓	✓		✓	✓	
MF4245	OPEN	3046	10	✓	✓		✓	✓	
MF4253	OPEN	3046	10	✓	✓		✓	✓	
MF4255	OPEN	3046	10	✓	✓		✓	✓	
MF4263	OPEN	3046	10	✓	✓		✓	✓	
MF4270	OPEN	3046	10	✓	✓		✓	✓	
MF4800	OPEN	2250	20			✓			✓
MF4840	OPEN	2250	20			✓			✓
MF4880	OPEN	2250	20			✓			✓
MF4900	OPEN	2250	20			✓			✓
MF6150	OPEN (4)	2610	14.9		✓		✓	✓	
MF6170	OPEN (4)	2610	14.9		✓		✓	✓	
MF6180	OPEN (4)	2610	14.9		✓		✓	✓	
MF8120	LS CLOSED	2600	26		✓		✓	✓	
MF8140	LS CLOSED	2900	26		✓		✓	✓	
MF8150	LS CLOSED	2900	26		✓		✓	✓	
MF8160	LS CLOSED	2900	26		✓		✓	✓	

General Notes:

- A) The hydraulic systems on Massey Ferguson tractors may not have been intended for the continuous duty operation of a hydraulic driven sprayer pump. Auxiliary oil cooling may be necessary. Please consult Massey Ferguson before installing a hydraulic motor driven sprayer pump.
- B) On tractors with two hydraulic pumps, shut off the combining valve located on the right side of the tractor so the remote ports get only open center flow.

- (1) Select model FMC-HYD-210 when pumping pressures between 60 and 100 PSI are required.
- (2) Consult Massey Ferguson to determine the type hydraulic system and the method for regulating the hydraulic oil to the Ace Pump.
- (3) Use left hand remote ports to connect hydraulic driven pump. Right hand spool has priority over 3 point hitch.
- (4) These tractors have an optional LS CLOSED hydraulic system. For the LS Closed system the Max. Remote Pressure is 2900 PSI and Max. Remote Flow is 26 GPM.

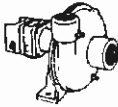
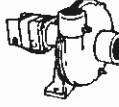
STEIGER	Open or Closed Center System	Maximum Pressure Remote Outlets	Maximum Flow Remote Outlets US GPM	ACE PUMP MODEL RECOMMENDATION					
				1 X 1 SERIES			1 x 1 SERIES	2 x 1 SERIES	
				FMC-HYD-204	FMC-HYD-210	FMC-HYD-310	FMC-150-HYD-208	FMC-200-HYD-210 FMC-200-HYD-304	FMC-200-HYD-310
WILDCAT RC-210	OPEN	2250	20			✓			✓
BEARCAT ST-220	OPEN	2250	20			✓			✓
BEARCAT ST-25	OPEN	2250	20			✓			✓
BEARCAT CM-225	OPEN	2250	20			✓			✓
COUGAR ST-250	OPEN	2250	20			✓			✓
COUGAR CM-150	OPEN	2250	20			✓			✓
COUGAR ST-251	OPEN	2250	20			✓			✓
COUGAR ST-270	OPEN	2250	20			✓			✓
COUGAR PT-270	OPEN	2250	20			✓			✓
COUGAR CS-280	OPEN	2250	20			✓			✓

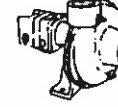
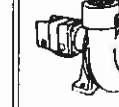
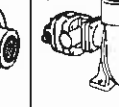
Steiger (Continued)	Open or Closed Center System	Maximum Pressure Remote Outlets	Maximum Flow Remote Outlets US GPM	1 X 1 SERIES			1 x 1 SERIES	2 x 1 SERIES	
				FMC-HYD-204	FMC-HYD-210	FMC-HYD-310	FMC-150-HYD-206	FMC-200-HYD-210 FMC-200-HYD-304	FMC-200-HYD-310
PANTHER PTA-297	OPEN	2250	20			✓			✓
PANTHER ST-310	OPEN	2250	20			✓			✓
PANTHER PTA-310	OPEN	2250	20			✓			✓
PANTHER ST-320	OPEN	2250	20			✓			✓
PANTHER ST-325	OPEN	2250	20			✓			✓
PANTHER KS-325	OPEN	2250	20			✓			✓
PANTHER PT-350	OPEN	2250	20			✓			✓
PANTHER KM-360	OPEN	2250	20			✓			✓
PANTHER CS-360	OPEN	2250	20			✓			✓
PANTHER KS-360	OPEN	2250	20			✓			✓
COUGAR KR-1225	LS CLOSED	2500	30		✓		✓	✓	
COUGAR CR-1225	LS CLOSED	2500	30		✓		✓	✓	
COUGAR KR-1280	LS CLOSED	2500	30		✓		✓	✓	
COUGAR CR-1280	LS CLOSED	2500	30		✓		✓	✓	
PANTHER CP-1325	LS CLOSED	2500	30		✓		✓	✓	
PANTHER KP-1325	LS CLOSED	2500	30		✓		✓	✓	
PANTHER CP-1360	LS CLOSED	2500	30		✓		✓	✓	
PANTHER KP-1360	LS CLOSED	2500	30		✓		✓	✓	
PANTHER CP-1400	LS CLOSED	2500	30		✓		✓	✓	
PANTHER KP-1400	LS CLOSED	2500	30		✓		✓	✓	
VERSATILE.	Open or Closed Center System	Maximum Pressure Remote Outlets	Maximum Flow Remote Outlets US GPM	ACE PUMP MODEL RECOMMENDATION					
									
				1 X 1 SERIES			1 x 1 SERIES	2 x 1 SERIES	
				FMC-HYD-204	FMC-HYD-210	FMC-HYD-310	FMC-150-HYD-206	FMC-200-HYD-210 FMC-200-HYD-304	FMC-200-HYD-310
118	OPEN	2000	16.5		✓			✓	
145	OPEN	2000	16.5		✓			✓	
150	OPEN	2500	15		✓			✓	
256	LS CLOSED	2500	25.2		✓		✓	✓	
276	LS CLOSED	2500	25.2		✓		✓	✓	
500	OPEN	2300	24			✓			✓
555	OPEN	2400	23.2			✓			✓
700	OPEN	2000	24			✓			✓
750 SERIES II	OPEN	2200	23			✓			✓
756	LS CLOSED	2250	20		✓		✓	✓	
800 SERIES II	OPEN	2200	23			✓			✓
825 SERIES II	OPEN	2300	23.5			✓			✓
835	OPEN	2300	23.5			✓			✓
836	LS CLOSED	2500	25.2		✓		✓	✓	
850 SERIES II	OPEN	2300	23.5			✓			✓
855	OPEN	2300	23.5			✓			✓
856	LS CLOSED	2500	25.2		✓		✓	✓	
875	OPEN	2300	23.5			✓			✓
876	LS CLOSED	2500	25.2		✓		✓	✓	
895	OPEN	2400	23.6			✓			✓
900	OPEN	2000	24			✓			✓
905	OPEN	2300	23.5			✓			✓
936	LS CLOSED	2500	25.2		✓		✓	✓	
955	OPEN	2500	23			✓			✓
956	LS CLOSED	2500	25.2		✓		✓	✓	
975	OPEN	2500	23			✓			✓
976	LS CLOSED	2500	25.2		✓		✓	✓	
1150	LS CLOSED	2500	27		✓		✓	✓	
1156	LS CLOSED	2250	20		✓		✓	✓	
9030	LS CLOSED	2400	25		✓		✓	✓	
9280	LS CLOSED	2400	25/30		✓		✓	✓	
9480	LS CLOSED	2400	25/30		✓		✓	✓	
9680	LS CLOSED	2400	25/30		✓		✓	✓	
9880	LS CLOSED	2400	25/30		✓		✓	✓	



ACE PUMP MODEL RECOMMENDATION

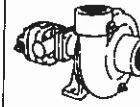
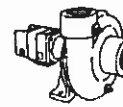
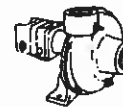
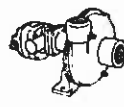
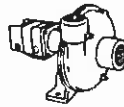
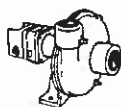

Open or
Closed
Center
System

Maximum
Pressure
Remote
Outlets

Maximum
Flow
Remote
Outlets
US GPM

1 X 1 SERIES

1 x 1 SERIES

2 x 1 SERIES

FMC-HYD-204

FMC-HYD-210

FMC-HYD-310

FMC-150-HYD-206

FMC-200-HYD-210
FMC-200-HYD-304

FMC-200-HYD-310

60 (1)	OPEN	2200	20				✓			✓
80 (1)	OPEN	2200	20				✓			✓
100	PC CLOSED	2250	19	✓				✓		
120	PC CLOSED	2250	22	✓					✓	
125	PC CLOSED	2250	22	✓				✓		
140	PC CLOSED	2250	22	✓				✓		
145	PC CLOSED	2250	22	✓					✓	
160	PC CLOSED	2250	22	✓				✓		
170	PC CLOSED	2250	22	✓					✓	
185	PC CLOSED	2250	22	✓				✓		
195	PC CLOSED	2500	22	✓				✓		✓
2-30	OPEN	2130	5.4	✓						
2-35	OPEN	2130	5	✓						
2-45	OPEN	2413	8.5	✓				✓		
2-50	OPEN	2130	5.99	✓						
2-55	OPEN	2515	11.9	✓				✓		
2-60	OPEN	2130	5.8	✓						
2-62	OPEN	2413	8.5	✓				✓		
2-65	OPEN	2415	11.9	✓				✓		
2-70	OPEN	2050	14.6		✓			✓		✓
2-75	OPEN	2987	9.3/12	✓				✓		
2-85	PC CLOSED	2250	20	✓				✓		
2-88	PC CLOSED	2250	21	✓				✓		
2-105	PC CLOSED	2250	20	✓				✓		
2-110	PC CLOSED	2250	21	✓				✓		
2-135	PC CLOSED	2250	21	✓				✓		
2-150	PC CLOSED	2250	20	✓				✓		
2-155	PC CLOSED	2300	20	✓				✓		
2-160	PC CLOSED	2300	20	✓				✓		✓
2-180	PC CLOSED	2300	22	✓				✓		
4-150	PC CLOSED	2250	22	✓				✓		
4-175	PC CLOSED	2250	22	✓				✓		
4-180	PC CLOSED	2250	22	✓				✓		
4-210	PC CLOSED	2250	20	✓				✓		
4-225	PC CLOSED	2250	22	✓				✓		
4-270	PC CLOSED	2250	22	✓				✓		
6045	OPEN	2775	11	✓			✓	✓		
6065	OPEN	2610	9.6		✓			✓		✓
6085	OPEN	2610	14.5		✓			✓		✓
6105	OPEN	2610	15.9		✓			✓		✓
6124	LS CLOSED	2900	27	✓		✓		✓		
6125	PC CLOSED	2250	22	✓				✓		
6144	LS CLOSED	2900	27	✓		✓		✓		
6145	PC CLOSED	2250	22	✓				✓		
6175	PC CLOSED	2250	22	✓				✓		
6195	PC CLOSED	2250	22	✓				✓		✓
6215	PC CLOSED	2750	22	✓				✓		✓
6410	OPEN	3045	17		✓			✓		✓
6510	OPEN	3045	17		✓			✓		✓
6710	LS CLOSED	2900	27.7		✓			✓		✓
6810	LS CLOSED	2900	27.7		✓			✓		✓
8310	LS CLOSED	2900	27.7		✓			✓		✓
8410	LS CLOSED	2900	27.7		✓			✓		✓

(1) Connect the hydraulic hoses from the Ace sprayer pump to the Power Beyond Circuit rather than using the remote hydraulic ports.

This Ace TRACTOR HYDRAULIC SYSTEM GUIDE has been copyrighted and may not be reproduced without the written permission of Ace Pump Corp.

ACE PUMP CORPORATION

P.O. Box 13187 • 1650 Channel Ave. • Memphis, TN 38113 • Phone 901-948-8514 • FAX 901-774-6147