

OPERATOR'S MANUAL

and Set-Up Instructions for
RUNNING GEARS

1074 Running Gear



J. & M. Mfg. Co., Inc.
P.O. Box 547 Ft. Recovery, OH 45846
Ph: (419) 375-2376 Fax: (419) 375-2708
www.jm-inc.com

TO THE DEALER:

Read manual instructions and safety rules. Make sure all items on the Dealer’s Pre-Delivery and Delivery Check Lists in the Operator’s Manual are completed before releasing equipment to the owner.

The dealer must complete the Warranty Registration Card attached to the front inside cover of this manual and return to J. & M. Mfg. Co., Inc. at the address indicated on the card. **Warranty claims will be denied if the Warranty Registration Card has not been completed and returned.**

EXPRESS WARRANTY:

J. & M. Mfg. Co. Inc. warrants against defects in construction or materials for a period of ONE year. We reserve the right to inspect and decide whether material or construction was faulty or whether abuse or accident voids our guarantee.

Warranty service must be performed by a dealer or service center authorized by J. & M. Mfg. Co. Inc. to sell and/or service the type of product involved, which will use only new or remanufactured parts or components furnished by J. & M. Mfg. Co. Inc. Warranty service will be performed without charge to the purchaser for parts or labor based on the Warranty Labor Times schedule. Under no circumstance will allowable labor times extend beyond the maximum hours indicated in the Warranty Labor Times schedule for each warranty procedure. The purchaser will be responsible, however, for any service call and/or transportation of the product to and from the dealer or service center’s place of business, for any premium charged for overtime labor requested by the purchaser, and for any service and/or maintenance not directly related to any defect covered under the warranty. Costs associated with equipment rental, product down time, or product disposal are not warrantable and will not be accepted under any circumstance.

Each warranty term begins on the date of product delivery to the purchaser. Under no circumstance will warranty be approved unless (i) the product warranty registration card (attached to the inside of the Operator’s Manual) has been properly completed and submitted to the equipment manufacturer, and (ii) a warranty authorization number has been issued by the equipment manufacturer. This Warranty is effective only if the warranty registration card is returned within 30 days of purchase.

This warranty does not cover a component which fails, malfunctions or is damaged as a result of (i) improper modification or repair, (ii) accident, abuse or improper use, (iii) improper or insufficient maintenance, or (iv) normal wear or tear. This warranty does not cover products that are previously owned and extends solely to the original purchaser of the product. Should the original purchaser sell or otherwise transfer this product to a third party, this Warranty does not transfer to the third party purchaser in any way. J. & M. Mfg. Co. Inc. makes no warranty, express or implied, with respect to tires or other parts or accessories not manufactured by J. & M. Mfg. Co. Inc. Warranties for these items, if any, are provided separately by their respective manufacturers.

THIS WARRANTY IS EXPRESSLY IN LIEU OF ALL OTHER WARRANTIES OR CONDITIONS, EXPRESS, IMPLIED OR STATUTORY, INCLUDING ANY IMPLIED WARRANTY OF MERCHANTABILITY OR FITNESS FOR PARTICULAR PURPOSE.

In no event shall J. & M. Mfg. Co. Inc. be liable for special, direct, incidental or consequential damages of any kind. The exclusive remedy under this Warranty shall be repair or replacement of the defective component at J. & M. Mfg. Co. Inc’s. option. This is the entire agreement between J. & M. Mfg. Co. Inc. and the Owner about warranty and no J. & M. Mfg. Co. Inc. employee or dealer is authorized to make any additional warranty on behalf of J. & M. Mfg. Co. Inc.

The manufacturer reserves the right to make product design and material changes at any time without notice. They shall not incur any obligation or liability to incorporate such changes and improvements in products previously sold to any customer, nor shall they be obligated or liable for the replacement of previously sold products with products or parts incorporating such changes.

SERVICE:

The equipment you have purchased has been carefully manufactured to provide dependable and satisfactory use. Like all mechanical products, it will require cleaning and upkeep. Lubricate the unit as specified. Observe all safety information in this manual and safety signs on the equipment.

For service, your authorized J. & M. dealer has trained mechanics, genuine J. & M. service parts, and the necessary tools and equipment to handle all your needs.

Use only genuine J. & M. service parts. Substitute parts may void the warranty and may not meet standards required for safe and satisfactory operation. Record the model number and serial number of your equipment in the spaces provided:

Serial No.: _____ **Date of Purchase:** _____

Purchased From: _____

Provide this information to your dealer to obtain correct repair parts.

10 TON RUNNING GEAR SPECIFICATIONS

SPECIFICATIONS

Capacity	10 Ton
Weight (with tires)*	960 lbs
Width (c/c of tire)	74"
Spindle Size	2" diameter
Spring Balanced Tongue	Standard
Ground Height (to top of axle)	27"
Rocking Bolster	Optional
Tongue, Adjustable Quick Hitch	Standard
Adjustable Center Pole	Standard
Wheels - 6 bolt	15 x 8 or 15 x 10

*Weighed with 12.5L-15 tires



GENERAL INFORMATION

TO THE OWNER:

The purpose of this manual is to assist you in operating and maintaining your running gear in a safe manner. Read it carefully. It furnishes information and instructions that will help you achieve years of dependable performance and help maintain safe operating conditions. If this machine is used by an employee or is loaned or rented, make certain that the operator(s), prior to operating:

1. Is instructed in safe and proper use.
2. Reviews and understands the manual(s) pertaining to this machine.

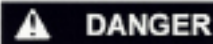
Throughout this manual, the term **IMPORTANT** is used to indicate that failure to observe can cause damage to equipment. The terms **CAUTION**, **WARNING** and **DANGER** are used in conjunction with the Safety-Alert Symbol, (a triangle with an exclamation mark), to indicate the degree of hazard for items of personal safety. When you see this symbol, carefully read the message that follows and be alert to the possibility of personal injury or death.

	This Safety-Alert symbol indicates a hazard and means ATTENTION! BECOME ALERT! YOUR SAFETY IS INVOLVED!
	Indicates an imminently hazardous situation that, if not avoided, will result in death or serious injury.
	Indicates a potentially hazardous situation that, if not avoided, could result in death or serious injury, and includes hazards that are exposed when guards are removed.
	Indicates a potentially hazardous situation that, if not avoided, may result in minor or moderate injury.
IMPORTANT	Indicates that failure to observe can cause damage to equipment.
NOTE	Indicates helpful information.

GENERAL INFORMATION

BOLT TORQUE CHART

Always tighten hardware to these values unless a different torque or tightening procedure is listed for a specific application.

Fasteners must always be replaced with the same grade as specified in the manual parts list.

Always use the proper tool for tightening hardware: SAE for SAE hardware and Metric for metric hardware.

Make sure fastener threads are clean and you start thread engagement properly.

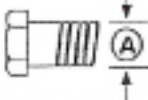

SAE SERIES TORQUE CHART



SAE Bolt Head Identification

SAE Grade 2 (No Dashes)



SAE Grade 5 (3 Radial Dashes)



SAE Grade 8 (6 Radial Dashes)

Diameter (Inches) ^(A)	Wrench Size	MARKING ON HEAD					
		SAE 2		SAE 5		SAE 8	
		Lbs.-Ft.	N-m	Lbs.-Ft.	N-m	Lbs.-Ft.	N-m
1/4	7/16"	6	8	10	13	14	18
5/16	1/2"	12	17	19	26	27	37
3/8	9/16"	23	31	35	47	49	67
7/16	5/8"	36	48	55	75	78	106
1/2	3/4"	55	75	85	115	120	163
9/16	13/16"	78	106	121	164	171	232
5/8	15/16"	110	149	170	230	240	325
3/4	1-1/8"	192	261	297	403	420	569
7/8	1-5/16"	306	416	474	642	669	907
1	1-1/2"	467	634	722	979	1020	1383

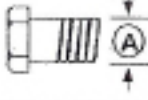

METRIC SERIES TORQUE CHART



Metric Bolt Head Identification

Metric Grade 8.8



Metric Grade 10.9

Diameter & Thread Pitch (Millimeters) ^(A)	Wrench Size	COARSE THREAD				FINE THREAD				Diameter & Thread Pitch (Millimeters) ^(A)
		MARKING ON HEAD								
		Metric 8.8		Metric 10.9		Metric 8.8		Metric 10.9		
		N-m	Lbs.-Ft.	N-m	Lbs.-Ft.	N-m	Lbs.-Ft.	N-m	Lbs.-Ft.	
6 x 1.0	10 mm	8	6	11	8	8	6	11	8	6 x 1.0
8 x 1.25	13 mm	20	15	27	20	21	16	29	22	8 x 1.0
10 x 1.5	16 mm	39	29	54	40	41	30	57	42	10 x 1.25
12 x 1.75	18 mm	68	50	94	70	75	55	103	76	12 x 1.25
14 x 2.0	21 mm	109	80	151	111	118	87	163	120	14 x 1.5
16 x 2.0	24 mm	169	125	234	173	181	133	250	184	16 x 1.5
18 x 2.5	27 mm	234	172	323	239	263	194	363	268	18 x 1.5
20 x 2.5	30 mm	330	244	457	337	367	270	507	374	20 x 1.5
22 x 2.5	34 mm	451	332	623	460	495	365	684	505	22 x 1.5
24 x 3.0	36 mm	571	421	790	583	623	459	861	635	24 x 2.0
30 x 3.0	46 mm	1175	867	1626	1199	1258	928	1740	1283	30 x 2.0

TABLE OF CONTENTS

INTRODUCTION	2
EXPRESS WARRANTY	2
SPECIFICATIONS	3
GENERAL INFORMATION	3
BOLT TORQUE CHART	4
SAFETY RULES	6
SAFETY SIGNS	7
SET-UP INSTRUCTIONS	7
OPERATION	8
ROUTINE MAINTENANCE	8
PARTS LIST/DIAGRAM	9
SERVICE RECORDS	10

SAFETY RULES

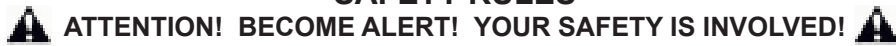

Safety is a primary concern in the design and manufacture of our products. Unfortunately, our efforts to provide safe equipment can be erased by an operator's single careless act. In addition, hazard control and accident prevention are dependent upon the awareness, concern, judgement, and proper training of personnel involved in the operation, transport, maintenance and storage of equipment.

Make certain that the operator(s), prior to operating is instructed in safe and proper use and reviews and understands the manual(s) pertaining to this machine.

Read this manual before you operate this machine. If you do not understand any part of this manual, or need more information, contact the manufacturer or your authorized dealer.

SAFETY

Understand that your safety and the safety of other persons is measured by how you service, and operate this machine. Know the positions and functions of all controls before you try to operate them. Make sure to check all controls in a safe area before starting your work.

The safety information given in this manual does not replace safety codes, federal, state or local laws. Make certain your machine has the proper equipment as designated by local laws and regulations.

A frequent cause of personal injury or death is from persons falling off equipment and being run over. Do not permit persons to ride on this machine.

Travel speeds should be such that complete control and machine stability is maintained at all times. Where possible, avoid operating near ditches, embankments and holes. Reduce speed when turning, crossing slopes and rough, slick or muddy surfaces.

Collision of high speed road traffic and slow moving machines can cause personal injury or death. On roads, use flasher lights according to local laws. Keep slow-moving-vehicle emblem visible. Pull over to let faster traffic pass.

Never adjust, service, clean, or lubricate running gear until all power is shut off.

Keep all safety shields in place.

Keep hands, feet, hair and clothing away from moving parts while unit is in operation.

Make sure that everyone is clear of equipment before applying power or moving the machine.

Make sure that the running gear is fastened securely to the tractor by using the proper hitch pin, clip and safety chains.

Never overload the running gear. Overloading the running gear is dangerous and can cause extensive

Do NOT exceed load limit or speeds in excess of 20 MPH. Rims, hubs and bearings are designed for heavy loads at slow speeds. Also be sure slow moving vehicle emblem is attached to rear of wagon.

Before unhooking the running gear from the towing unit, be sure to properly block the wheels to prevent the cart from moving.

SAFETY SIGNS

▲ ATTENTION! BECOME ALERT! YOUR SAFETY IS INVOLVED! ▲
Replace Immediately If Damaged or Missing!

IMPORTANT: Install new safety signs if the old signs are destroyed, lost, painted over or cannot be read. When parts are replaced that have safety signs, make sure you install a new sign with each new part. New signs are available from the manufacturer or your authorized

Ref. #	Description
1	Sign, Caution

Part #	Req'd
DC-111	1



DC-111



SET-UP INSTRUCTIONS FOR RUNNING GEAR

IMPORTANT: Set-up work to be performed by qualified servicemen only.

- 1) Mount tires on the wheels and inflate per the tire manufacturer's recommendations and instructions.
- 2) Mount the wheels to the hubs and tighten the hub nuts to 90 ft. lb. torque. Check the hub nuts after the first hour of operation, then every 10 hours of operation for the first 40 hours of use. These nuts must be kept tight at all times. Wheels that are improperly installed on the running gear, resulting in product failure, will nullify the warranty and shift the burden of liability to the owner/operator of the equipment.
- 3) Slide the coupling pole into the front and back assemblies, slipping the collar in the back assembly. Spacing of the coupling pole (approximate distance between holes on the coupling pole) should be 17". Distance from center of axle to center of axle is approximately 94".
- 4) Attach the standards (box attachment brackets) to the running gear, unless a rocking bolster is used.
- 5) Fasten the tongue to the front assembly using the tongue bolt (remove paint from the bolt before attaching) and jam nut. Attach the tongue spring to the bracket on the tongue and hitch assembly. Check underneath the tongue and make sure that the safety catch (7/8" x 2 1/4" bolt w/spacer) is secure.
- 6) Make sure to properly attach the gravity box (or other equipment) to the running gear. Bolt all four corners of the gravity box runners to the running gear. (If the box is used in rough terrain and it is not equipped with a rocking bolster, bolt a minimum of two corners and chain (or cable) the

OPERATING INSTRUCTION / MAINTENANCE

WARNING

BE CERTAIN THAT ALL POWER IS SHUT OFF BEFORE SERVICING EQUIPMENT.

Before equipment is put into service:

Has this manual and the operator's manual on the gravity box been read and clearly understood by the operator(s) of this machine?

Have all braces, bolts, nuts, lug bolts, and lug nuts been checked to ensure that they are properly fastened?

SAFETY CHAIN USER INSTRUCTIONS

- a) Secure the safety chain by looping it around the tongue support located on the underside of the outer tongue. Extend the chain through the support located on the underside of the inner tongue and connect to the towing machine's attaching bar.
- b) Be sure to run the safety chain through the support on the underside of the inner tongue. This will provide an intermediate support for the safety chain.
- c) Do Not allow more slack than necessary for articulation (max. 9 inches).
- d) Do Not use any intermediate support as the attaching point.
- e) Store the safety chain by securing it around the tongue supports.
- f) Replace the safety chain if one or more links or end fittings are broken, stretched or otherwise damaged or deformed.

Have all danger, warning, caution and important signs on the equipment been read and clearly understood? If employees or others use or are near this equipment, make sure that they also have read and understood all danger, warning caution and important signs on the equipment and have also read the operator's manual.

Have the wheel bearings been inspected? Repack with grease if needed. Grease both the tongue bolt and the hitch bolt.

Do not exceed the load limit of the unit.

SYSTEM REQUIREMENTS:

WARNING

Tow Loads Safely

Stopping distance increases with speed and weight of towed loads, and on slopes. Towed loads without brakes that are too heavy for the tractor or are towed too fast can cause loss of control. Consider the total weight of the equipment and its load.

Observe these recommended maximum road speeds, or local speed limits which may be lower:

If towed equipment does not have brakes, do not travel more than 32 km/h (20 mph) and do not tow loads more than 1.5 times the tractor weight.

Ensure the load does not exceed the recommended weight ratio. Use additional caution when towing loads under adverse surface conditions, when turning, and on inclines.

IMPORTANT:

Keep the tires properly inflated. Both under inflation and over inflation can greatly reduce tire life.

Inspect bracing and welds and repair if needed. Failure to repair could cause extensive damage and greatly reduce the life of the unit.

Inspect tie rods and replace the bronze bushings in the steering assembly when needed.

Repack the bearings in the hub assemblies once a year or as needed. Use a good quality bearing lubricant such as Bearing Gard MK1 or equivalent. NOTE: Grease zerks on hub caps are for between scheduled service lubrication.

RUNNING GEAR PARTS LIST

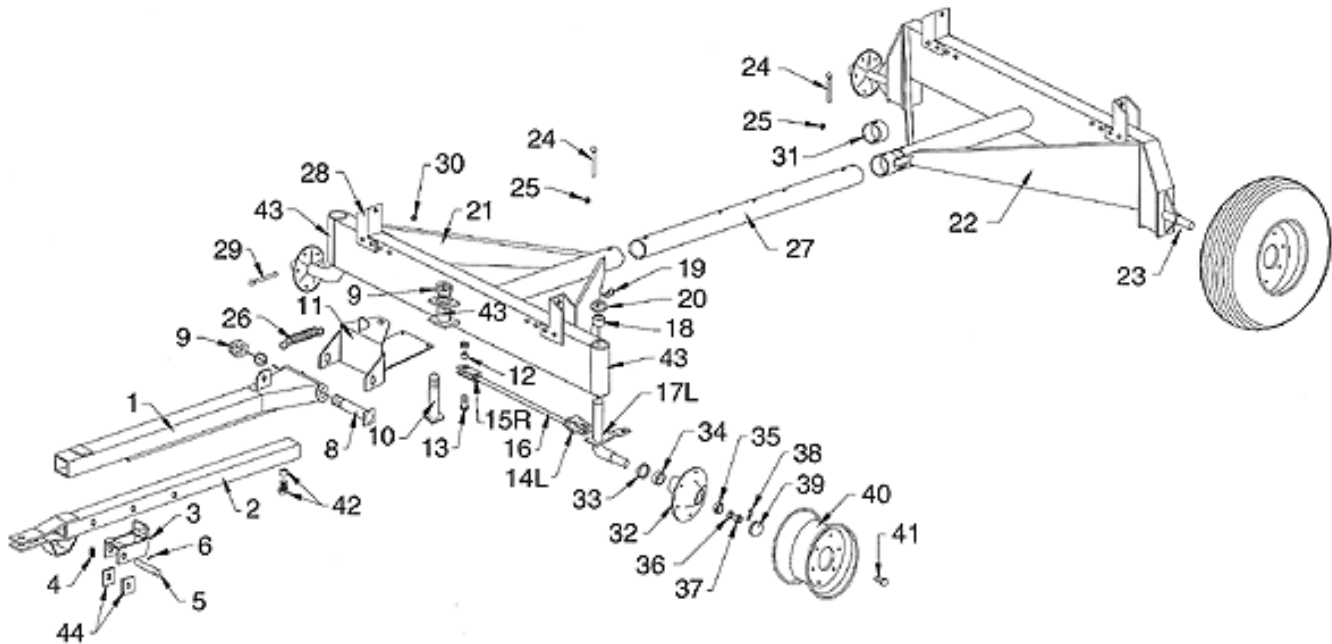

#	Part #	Description	Qty	#	Part #	Description	Qty
1	OT-610NS	Adj. Tongue Outer Weldment	1	23	RS-10	Rear Spindle	2
2	IT-610NS	Adj. Tongue Inner Weldment	1	24	MB-345	3/4" x 5" Bolt	2
3	TL-610NS	Tongue Latch Weldment	1	25	LN-34	3/4" Hex Lock Nut	2
4	SS-615NS	Small Spring in Latch	1	26	TS-615	Large Tongue Spring	1
5	LS-610	Latch Pivot Shaft, 1" Dia.	1	27	CP-312	Coupling Pole	1
6	CP-112	Cotter Pin	2	28	ST-10	Standards	4
7	ST-610	Standard Tongue	1	29	MB-38412	3/8" Bolt	8
8	TB-610	Tongue Pivot Bolt	1	30	HN-38	3/8" Hex Nut	8
9	HN-114	Regular Hex Nut	2	31	CL-4	Collar to Coupling Pole	1
10	KP-610	King Pin Bolt	1	32	105164	Hub including Lug Bolts & Nuts	4
11	HW-10	Hitch Weldment	1	33	105166	Grease Seal	4
12	BB-58	Bronze Bushing, 5/8"	4	34	105771	Inner Bearing, Large	4
13	SB-58	Special Step Bolt, 5/8"	4	35	104082	Outer Bearing, Small	4
14L	TRE-78L	Tie Rod End, Left	2	36	104581	Washer	4
14R	TRE-78R	Tie Rod End, Right	2	37	103289	Slotted Spindle Nut	4
15L	HN-78L	7/8"-14 Hex Nut, Left	2	38	CP-316	Cotter Pin	4
15R	HN-78R	7/8"-14 Hex Nut, Right	2	39	103969	Dust Cap	4
16	TR-22316	Tie Rod, 7/8" Dia.	2	40	WR-1510	Wheel Rim, 6 bolt, 15x10	4
17L	SA-10L	Spindle & Arm Weldment, Left	1	41	105144	Lug (Wheel) Bolt	24
17R	SA-10R	Spindle & Arm Weldment, Right	1	42	78214-BS	7/8" x 2 1/4" HHMB with spacer	1
18	EB-2	End Spindle Bronze Bushing	4	43	1633	Grease Fitting	4
19	CP-212	Cotter Pin	2	44	SB-212	Spacer Block	2
20	MB-2	Machine Bushing	2	45	TSB-2	Tongue Spring Bracket (2 pcs)	1
21	FA-10	Front Axle Weldment	1	46	105770	Inner Cup, Large	4
22	RA-10	Rear Axle Assembly	1	47	104081	Outer Cup, Small	4

SERVICE / MAINTENANCE RECORD

DATE	DESCRIPTION	NOTES